

# Colt Cowls + Flues

Now with ISO14001 status.

Better for you.  
Better for the planet.

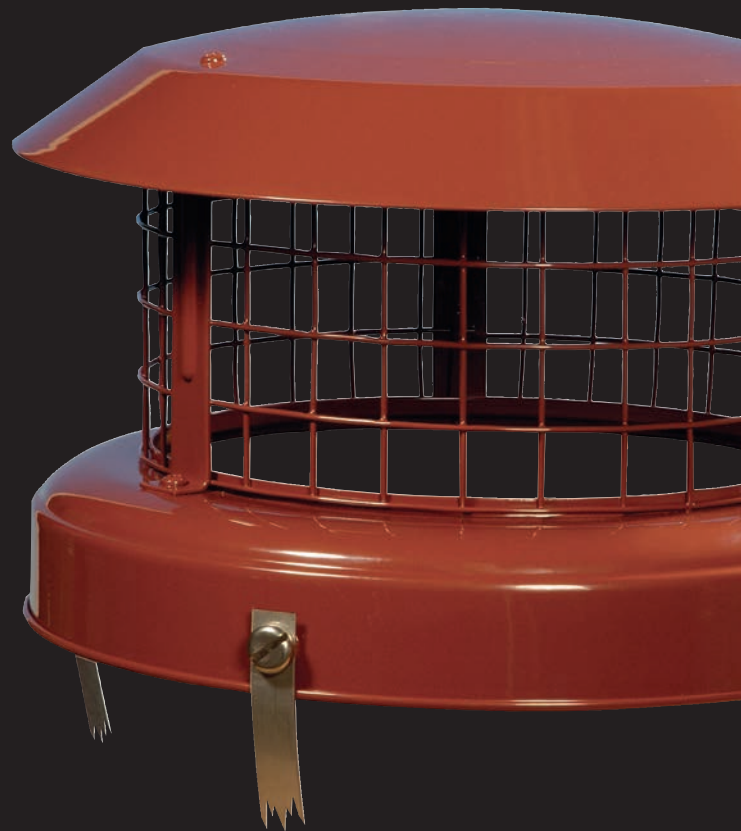

Tel 01243 781 559  
[www.coltcowls.co.uk](http://www.coltcowls.co.uk)

**Colt Cowls**

Chimneys Terminals Flues

# Colt Cows

## The Original

The Colt Cowl range of products has been solving chimney problems since 1931 when the original Colt Cowl was first introduced.

The market leading range comes with the following benefits;

- The highest quality chimney cowls available
- Free next day delivery anywhere in mainland UK (does not include islands or Scottish Highlands)
- Competitive prices
- Technical back up from expert sales team and over 90 years experience of making Colt Cows
- Constant development of new and exciting product ranges

The Colt Cowl range really does provide the best quality and value available for trade and domestic customers.

## Colt Cows Quality Mark



Having led the market since 1931, Colt Cows are rightly proud of the quality of chimney cowls that we produce. All Colt Cows are manufactured in an ISO 9001:2015 accredited factory. Where relevant, all Colt chimney cowls are tested and certified under new regulation BSEN 16475-7:2016 and BSEN 1856-1:2003. At all times Colt Cows strives to use the best quality materials and fixings available. Finally, Colt Cows also passes the most rigorous of all tests, that being the test of time. Several million Colt Cows are still functioning on chimneys decades after installation. Only where you see a holographic version of this logo can you be sure that you are buying genuine Colt Cows.

## Gold Quality Mark



From now on ALL Colt Cowl products with a Kitemark will be marked as such and also include a gold holographic sticker.



## Environmentally Friendly

Colt Cows are an environmentally friendly company proudly boasting ISO14001 status. This internationally recognised standard provides a framework for organisations to have an effective environmental management system, assuring company management, employees and customers that environmental impact is being measured and continually improved.

## Money Back Guarantee



On certain products an unconditional Money Back Guarantee is offered. Experience has shown that only in isolated cases will our product range fail to solve the problem encountered. If, having installed the product correctly, the problem still remains, simply return it to the place of purchase within a reasonable period, with full proof of purchase, for a full refund.

The MBG applies to all products with the MBG symbol displayed. This guarantee will not apply where a product has been subjected to temperatures in excess of the recommended operating temperature and where excessive wind speeds are experienced. This offer does not affect your statutory rights.

## Fitting Instruction Videos

On many products Colt Cows provide instructive, easy to follow videos. Where you see this symbol, simply find the relevant product on our website.

Visit our website to watch our selection of easy-to-follow instruction videos.



## Eco-Friendly Packaging



Colt Cows are continually taking steps to reduce the impact of our packaging on the environment.

Where you see this symbol, the product has been repackaged to remove unnecessary plastic and is now made of fully recyclable cardboard. Over 90% of our top selling products now have Eco Packaging.

## BSI Kitemark



You may well recognise the symbol above. It is usually seen on products where safety is paramount and can be on anything from crash helmets to smoke alarms. It is owned and operated by the British Standards Institute (BSI) and only awarded to companies who can demonstrate that they are able to meet the requirements of the relevant British and European (BSEN) quality standards.

## Next Day Delivery\*



All Colt Cowl products, unless advised differently, come with free next working day delivery\* (order values above £150.00 ex VAT).

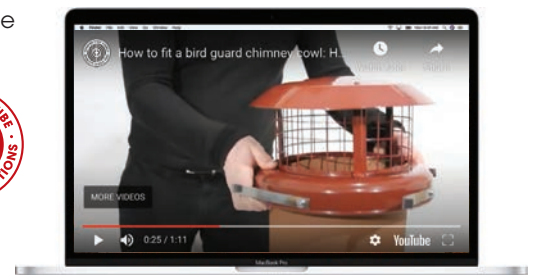

# Sales: 01243 781 559

Dimensions given refer to internal diameter of pot or flue. All prices exclude VAT. \*Minimum carriage paid order £150 Ex VAT. £10 Ex VAT carriage applies if under £150 Ex VAT NET order.

## Bird & Rain Guards, Chimney Caps

### 3

High Top



### 4-5

Birdguards & Rain Tops



### 6

Top Lid & Chimney Sheep Draught Excluder



## Static Anti-downdraught Cows

### 7-8

Colt Top, Colt Top Trade & Colt Top 2



### 9

Econotops®



### 10

The Original Colt Cowl & Accessories



## Revolving & Electric Anti-downdraught cowls

### 11

Rotorvent Ultralite 2®



### 12

Rotorvent Turbolite® & Mini Rotorvent®



### 13

Electric Chimney Fans - The Draft Booster



## Chimney Liner Cows

### 14

High Top Flex



### 15

Colt Top Flex



## Chimney Liner

### 16

flexiwall® Chimney Liner



### 17

Turner & Wilson Twinflex Chimney Liner



## Chimney Liner Installation Parts

### 18

Essential Installation Components



### 19

Specialist Installation Components



### 20

Flue Insulation & Liner Cows



## Stove Pipe & Accessories

### 21-22

Vitreous Enamel Flue Pipe & Accessories



## Stove Glass & Rope

### 21-22

Replacement Stove Glass

Use our easy drop-down or call for an instant quote!





## High Top Birdguard Solid Fuel

Order code	Reference	Size mm
CTHTS0001	High Top	170-250

The High Top is designed to prevent unwanted bird and animal entry and to reduce the potential for clogging by soot or debris.

- Hugely popular and superb value for money
- Fits all flues 170-250mm internal diameter
- 25 mm corrosion resistant mesh
- Strap fixing
- Maximum outside diameter of pot 285mm

### Fuel Type Chart

	Coal	Wood	Gas	Oil	Smokeless Fuels
High Top Solid Fuel Birdguard	✓	✓		✓	✓
High Top Gas Birdguard			✓		
High Top Stainless Steel 316 Birdguard	✓	✓		✓	✓

## High Top Birdguard Gas



Order code	Reference	Size mm
CTHTSGA01	Gas High Top	170-250

- Fits all flue sizes 170-250mm internal diameter
- For use on gas fires (BS5871)
- Strap fixing
- Corrosion resistant stainless steel mesh birdguard. Same birdguard mesh as Colt Top and Colt Top 2 to meet BS5871 Part 3
- Maximum outside diameter of pot 285mm

## High Top Birdguard Buff



Order code	Reference	Size mm
CTHTSBF01	High Top (Buff)	170-250

- For solid fuel
- Fits all flues 170-250mm internal diameter
- Buff/cream finish
- Longer lasting material
- Strap fixing
- Maximum outside diameter of pot 285mm

## Overize Pot Adapter



Order code	Reference
CCOSA002	Pot Adapter (Flanged Top)*

Optional oversize adaptor for use with large chimney pots and flues.

- Can fit chimney pots with an outside diameter of 390mm
- Can be used in conjunction with High Top range
- Stainless steel strap fixing kit
- Painted finish which is highly resistant to the corrosive effects of smokeless fuels
- Painted terracotta finish blends in well with roof top colours
- Fits High Top Birdguard range

\* Flanged Top fits Colt Top 2, High Top Birdguard range and Top Lid

# Sales: 01243 781 559

Dimensions given refer to internal diameter of pot or flue. All prices exclude VAT. Minimum carriage paid order £150 Ex VAT. £10 Ex VAT carriage applies if under £150 Ex VAT NET order.





## High Top Birdguard 316 Stainless Steel

Order code	Reference	Size mm
CTHTS316	High Top Birdguard 316	170-250

- Made from durable 316 grade stainless steel
- Suitable for all solid fuels including logs, coal and all smokeless fuels (Anthracite, Phurnacite, Coke)
- Fits all flues 170-250mm internal diameter
- Terracotta finish
- Longer lasting material
- Strap fixing
- Maximum outside diameter of pot 285mm
- Kitemarked product
- Lifetime guarantee



KM 645037  
BS EN 16475-7:2016



## Decorative Chimney Birdguard



Order code	Reference	Size mm
DCBG0002	Decorative Birdguard	150-250

Ornate birdguard made from steel.

- Hardwearing M10 Steel
- Painted Finish

## Rain Top



Order code	Reference	Size mm
BGRT0201	Rain Top Earthenware	150-250

This general application Rain Top reduces rain entry.

- Strong durable galvanised steel
- Corrosion resistant painted finish
- Mesh integral to the product

## Fuel Type Chart

	Coal	Wood	Gas	Oil	Smokeless Fuels
Rain Top - Earthenware	✓	✓		✓	
Decorative Chimney Birdguard	✓	✓		✓	

## Square Birdguard Stainless Steel



Order code	Reference	Size mm
SSSQBG01	Square Birdguard Stainless Steel Terracotta	250x250

New from Colt Cowls is the square birdguard for use on chimney pots up to 250mm x 250mm. Made entirely from stainless steel and powder coated in terracotta.

- Fits chimney pots up to 250 x 250mm
- 25mm square birdguard mesh suitable for solid fuels (including smokeless fuels)
- Comes complete with jubilee fixing strap

## Cone Top Birdguard Stainless Steel



Order code	Reference	Size mm
CTBGSS001	Cone Top	110-260

General application ornate cone shaped stainless steel birdguard for use on solid fuel.

- Lightweight and strong
- Made from durable stainless steel
- Space saving. Great for installers as they take up very little space when stored in a stock room or van
- Comes complete with strap fixing kit
- Mesh suitable for use on solid fuel
- Can be adapted to smaller and square pots

## Spark Arrester



Order code	Reference	Size mm
CSKA0002	Spark Arrester	125-250

- Ideal for shingled and thatched properties
- Steel and aluminium construction
- Combined effect of two meshes allows lit debris to self extinguish
- Reduction plate (see page 10) required on small pots ie where pot size is smaller than opening of Arrester

## Chimney Birdguard

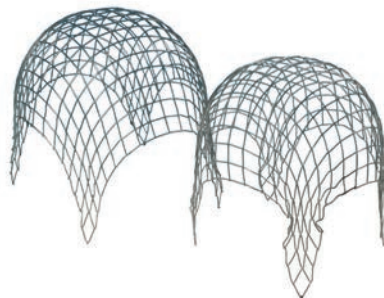

Order code	Reference	Size mm
LSCB0200	Birdguard	200
LSCB0225	Birdguard	225

General application birdguard with multi fuel use in galvanised steel.

- Pushes into flue pipe
- Self adjusts to fit

### Fuel Type Chart

	Coal	Wood	Gas	Oil	Smokeless Fuels
Square Birdguard Stainless Steel	✓	✓		✓	✓
Cone Top Birdguard	✓	✓		✓	✓
Spark Arrester	✓	✓		✓	✓
Chimney Birdguard	✓	✓		✓	

# Top Lid & Chimney Sheep Draught Excluder

## Top Lid 3



Order code	Reference	Size mm
CCTLB003	Top Lid	125-250

The Top Lid is used to cap off unused chimneys to save heat loss and stop bird and rain ingress.

- Durable steel
- Terracotta painted finish
- Fits flue sizes 125-250mm
- Strap fixing
- New top cap with improved ventilation



Top Lid 3 on a pot.

## Chimney Sheep Draught Excluders

**This amazing product helps prevent heat from escaping up chimneys, reducing cold draughts while saving the typical household money.**

Chimney Sheeps are very environmentally friendly, being made from the durable naturally hygroscopic wool of the Herdwick sheep. Once inserted into a chimney flue, the 4.43 tog-rated Chimney Sheep acts like a duvet blocking airflow, insulating the chimney, whilst allowing sufficient ventilation through the wool. They come with a 6" handle and 6" extension rod, giving 12" of total reach.

Unlike inflatable chimney blockers and chimney umbrellas, which require a small gap to be left in your flue to allow ventilation, the woollen pad of the Chimney Sheep compresses to fit flues of all shapes and sizes, leaving no gaps for draughts. This prevents heat loss far more efficiently than any other chimney draught excluder.

- Rigorously tested by BSRIA and University of Liverpool
- Stops heat from escaping while blocking cold air from coming down the chimney - can reduce energy bills by £50 p/year
- Reduces chimney noise
- Durable & washable environmentally-friendly felt head
- Made in the UK
- Easily removable, so can be used in flues that are still intended to be active

**Ideal for use with a chimney cap**



Order Code	Reference	Size mm
CA007	Chimney Sheep (Square)	330 x 330
CA010	Chimney Sheep (Oblong)	400 x 230
CA024	Chimney Sheep (Oblong)	400 x 150
CA040	Chimney Sheep (Oblong)	915 x 350
CA042	Chimney Sheep (Oblong)	500 x 300
CA045	Chimney Sheep (Oblong)	500 x 200
CA049	Chimney Sheep (Oblong)	810 x 405
CA057	Chimney Sheep (Oblong)	609 x 405
CA026	Chimney Sheep (Circular)	300
CA041	Chimney Sheep (Circular)	250
CA027	Chunky Extension Rod	150



## Colt Top Range

Colt Tops work on the same principle as Colt Cowls but with increased efficiency as their circular shape creates lift whichever direction the wind is blowing, eliminating downdraught. Rain drains help divert water outside the chimney pot.

Colt Top All Purpose, Gas, Trade and Colt Top 2's have been tested to and under the test conditions of BSEN 16475-7:2016 & BSEN-1856-1:2003.

### Fuel Type Chart - Colt Top

	Coal	Wood	Gas	Oil	Smokeless Fuels
Colt Top Aluminium	✓*	✓*	✓	✓	
Colt Top Brown	✓*	✓*	✓	✓	✓
Colt Top Trade	✓	✓		✓	✓

\* recommend removing integral birdguard

**FREE display stand with orders of 12 Colt Tops and over**



## Colt Top All Purpose



Order code	Reference	Size mm
CTAP0001	Colt Top All Purpose	125-250
CTGABF01	Colt Top AP Buff	125-250

As Colt Top Gas - but additionally with:

- Painted finish which is highly resistant to corrosive effects of smokeless fuels
- Suitable for all fuels
- Optional strap fixing in stainless steel
- Tested to BSEN 16475-7:2016 & BSEN-1856-1:2003
- Reduces rain entry



Also available in buff  
Order code CTGABF01



Stainless steel hook bolts and wing nuts



Integral birdguard



Strap fixing kit

## Colt Top Trade



Order code	Reference	Size mm
CTAP0001T	Colt Top Trade	125-250

As Colt Top All Purpose but WITHOUT integral stainless steel birdguard and display packaging.

- Suitable for solid fuel only
- Hook bolt fixing only
- Tested to BSEN 16475-7:2016 & BSEN-1856-1:2003



## Colt Top Gas



Order code	Reference	Size mm
CTGA0001	Colt Top Gas	125-250

- Static cowl in aluminium
- Stainless steel hook bolts and wing nuts
- Tested to BSEN 16475-7:2016 & BSEN-1856-1:2003
- Fully assembled
- No special tools needed
- Effective when wind blows from any direction
- Unconditional Money Back Guarantee
- Withstands flue temperatures up to 200°C
- 135mm height x 435mm width
- For use with most fuel types (see chart)
- Optional strap fixing in stainless steel

**Sales: 01243 781 559**

Dimensions given refer to internal diameter of pot or flue.  
All prices exclude VAT. Minimum carriage paid order £150 Ex VAT.  
£10 Ex VAT carriage applies if under £150 Ex VAT NET order.



## Colt Top 2 All Purpose

Shown with strap fixing



Order code	Reference	Size mm
CTBRS2002	Colt Top 2 Brown (Strap)	170-250

Ideal for use with any fuel type and designed to match the majority of terracotta chimney pots. Corrosion resistant.

- As Colt Top 2 Gas – but additionally with:
- Painted finish which is highly resistant to the corrosive effects of smokeless fuels
  - Suitable for all fuels
  - Optional strap fixing in stainless steel
  - Maximum outside diameter of pot: 285mm
  - Tested to BSEN 16475-7:2016 & BSEN-1856-1:2003

## Colt Top 2 Gas

Shown with strap fixing

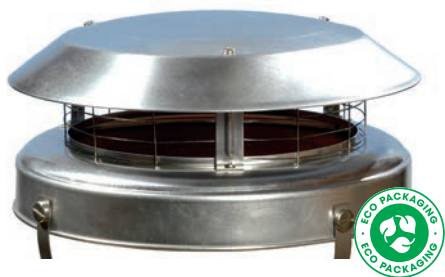

Order code	Reference	Size mm
CTALS2002	Colt Top 2 Aluminium (Strap Fix)	170-250

Manufactured from 1.6mm aluminium the Colt Top 2 Aluminium is supplied in natural form and can be used with the fuels shown in the chart.

- Fits all flue sizes 125-250mm
- Unconditional money back guarantee
- Ready assembled with stainless steel birdguard installed for fast fixing – no tools required
- For temperatures up to 200°C
- Strap fixing in stainless steel
- Stainless steel mesh birdguard
- Tested to BSEN 16475-7:2016 & BSEN-1856-1:2003

## Colt Top 2 Bolt

Shown with bolt fixing



Order code	Reference	Size mm
CTBR2002T	Colt Top 2 (Bolt)	170-250

Ideal for use with any fuel type and designed to match the majority of terracotta chimney pots. Corrosion resistant.

- As Colt Top 2 Gas – but additionally with:
- Painted finish which is highly resistant to the corrosive effects of smokeless fuels
  - Suitable for all fuels
  - Optional strap fixing in stainless steel
  - Maximum outside diameter of pot: 285mm
  - Tested to BSEN 16475-7:2016 & BSEN-1856-1:2003
  - Comes with pressure bolt fixing
  - Ideal for use on chimney pot with a low profile

### Fuel Type Chart - Colt Top 2

	Coal	Wood	Gas	Oil	Smokeless Fuels
Colt Top 2 Aluminium	✓*	✓*	✓	✓	
Colt Top 2 Brown	✓*	✓*	✓	✓	✓

\* recommend removing integral birdguard

## Econotop®



Order code	Reference	Size mm
ECONT001	Econotop	150-250

The Econotop® is a brand new addition to the anti-downdraught Colt chimney cowl range. As well as helping to stop smokey fireplaces, the Econotop® helps protect against bird and animal entry as well as rain ingress.

- Stops smokey fireplaces, eliminates bird entry and helps reduce rain ingress in chimneys
- Comes complete with strap fixing kit
- Tested to BSEN 16475-7:2016
- Low price

### Fuel Type Chart

	Coal	Wood	Gas	Oil	Smokeless Fuels
Econotop	✓*	✓*	✓	✓	
Econotop 316 Stainless Steel	✓*	✓*	✓	✓	✓

\* recommend removing integral birdguard

## Econotop® 316 Stainless Steel



**Lifetime Guarantee**



Order code	Reference	Size mm
ECONT316	Econotop 316	150-250

Suitable for all fuels including, logs, coal, and all smokeless fuels (Anthracite, Phurnacite, coke).

- Made entirely from 316 Stainless Steel
- New Econotop Anti-downdraught cowl
- Suitable for all fuels
- Stops smokey fireplaces, reduces rain and bird entry
- Lifetime guarantee



KM 645037  
BS EN 16475-7:2016

# Sales: 01243 781 559

Dimensions given refer to internal diameter of pot or flue.  
All prices exclude VAT. Minimum carriage paid order £150 Ex VAT.  
£10 Ex VAT carriage applies if under £150 Ex VAT NET order.

## Colt Cowl Natural

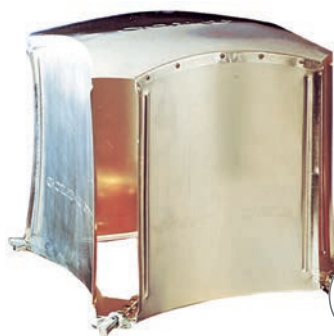

The Colt Cowl uses aerodynamic principles to create lift at the top of the chimney as air moves over it. This effect cures downdraught and shifts residual fumes and has been used in more than 3 million installations.

Order code	Reference	Size mm
CCNA0001	Colt Cowl	150-250

- 1.0mm aluminium
- Easy fixing with tried and tested hook bolts
- No tools required to fit
- Withstands flue temperatures up to 200°C
- Maintenance free
- 285mm height, width 310mm
- One size fits all flue sizes between 150-250mm
- Steel hook bolts electro plated

## Colt Cowl Universal Opening (and in stainless steel)



Colt Cowl Universal Opening with top removed



Colt Cowl Universal Opening in stainless steel

Order code	Reference	Size mm
CCTOP0001	Colt Cowl Universal Opening	150-250
CCTOPSS01	Colt Cowl Universal Opening stainless steel	150-250

The Colt Cowl Universal Opening is a traditional Colt Cowl which has been modified to include a top opening system. The Colt Cowl Universal has all the same specifications as the original Colt Cowl with the following features in addition.

- Now available in stainless steel
- Removable top opening cap to enable chimney to be swept from the top down.
- Durable stainless steel wingnut fixings for opening
- Integrated handle on opening cap for ease of use
- 4 integral stainless steel birdguards

- Black corrosion resistant finish on original model
- Suitable for all types of fuel
- One size fits all flue sizes between 150-250mm

### Fuel Type Chart

	Coal	Wood	Smokeless Fuels
Colt Cowl Natural	✓	✓	

Colt Cowl Universal	✓*	✓*	✓
---------------------	----	----	---

\* recommend removing integral birdguard

## Oversize Pot Adapter



Order code	Reference
CCOSA001	Pot Adapter (Flat Top)*
CCOSA002	Pot Adapter (Flanged Top)†

Optional oversize adaptor for use with large chimney pots and flues.

- Can fit chimney pots with an outside diameter of 390mm
- Can be used with Colt Top, High Top, Top Lid 3 and Rotorvent® range
- Stainless steel strap fixing kit
- Painted finish which is highly resistant to the corrosive effects of smokeless fuels
- Painted terracotta finish blends in well with roof top colours

## Colt Top Reduction Plate



Order code	Reference	Size mm
CTAD0100	Adapter	100
CTAD0125	Adapter	125
CTAD0150	Adapter	150
CTAD0175	Adapter	175
CTAD0200	Adapter	200

An accessory for use with Colt Tops when the flue dimension is between 125-175mm.

- 1.0mm aluminium
- Pre-drilled for easy installation to Colt Top
- Allows Colt Tops to meet gas regulations

## Colt Cowl Universal Strap Fixing Kit



Order code	Reference
CCUSFK010	Strap Fix

- Suitable for use on most products in Colt Cowl range
- High quality stainless steel

\* Flat Top fits Colt Top and Rotorvent® range † Flanged Top fits Colt Top 2, High Top Birdguard range and Top Lid



# Revolving & Electric Anti-Downdraught Cowls

The Rotorvent® range is widely regarded as the highest quality range of revolving chimney cowls available in the UK. The original Rotorvent® was introduced in 1997, and since that time the range has expanded to incorporate the many technical breakthroughs there have been in both design and manufacture.

## Performance

All Rotorvent® products have been designed with over 80 years experience of the aerodynamics of chimney cowls. The original Rotorvent® was developed with one prime objective:- to be the most efficient and powerful product on the market. This purpose has never been forgotten. In fact, we are so confident of the Rotorvent® range that all products within it are offered with the well known Colt Cowl unconditional money back guarantee.

All Rotorvent® products continue to be made using the unique fin fixing system introduced over a decade ago. This system ensures that the blades of the fin stay where they should. External welding or riveting of the fins has proven in the past to have failed, and so all Rotorvents® use centrifugal forces to their advantage. As the cowl accelerates, the tabs are forced inside the collar, putting no pressure whatsoever on the weld and indeed strengthening the structure.



## Fuel Type Chart

	Coal	Wood	Gas	Oil	Smokeless Fuels
Turbolite	✓	✓	✓	✓	✓
Ultralite 2		✓	✓	✓	
Mini Rotorvent®	✓	✓	✓	✓	✓

**The burning of wet or unseasoned wood and installation below 4m from the fire must be avoided when using revolving cowls**

## Unique Fin Fixing System

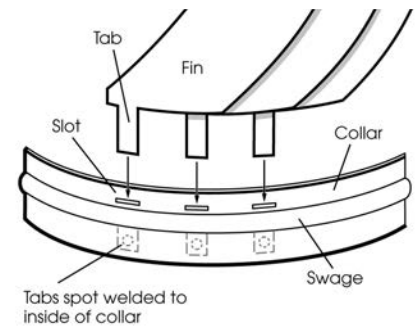

## Rotorvent Ultralite® 2



**The Rotorvent Ultralite® 2 is an extremely competitively priced, high quality revolving chimney cowl which can lay claim to being the lightest revolving cowl on the market.**

Weighing under 2kg, it is an amazing 40% lighter than the original Rotorvent®. This makes the product even more ideal for additional applications such as installation on top of methane vents as well as traditional flues and chimney pots.

Yet another technical breakthrough by Colt Cowls has meant that the Ultralite® revolving cowl is made substantially from aluminium.

- Fits 80–250mm flue sizes\*
- Comes complete with strap fixing kit
- Ultra light weight
- Highly aerodynamic pressure die cast aluminium base

- Rotor bowl now made from 1.2mm aluminium
  - For areas of consistently high wind speeds a static chimney cowl such as the Colt Top (page 7) may be more appropriate
  - Money back guarantee
  - Traditional Rotorvent® fin fixing method which combines threading the fin through the base of the structure and finishing with spot welding (see diagram)
  - Tested to BSEN 16475-7:2016 & BSEN-1856-1:2003
  - Does not require a birdguard
  - Highly competitively priced
- \*80–160mm requires hook bolts.

Order code	Reference	Size mm
CCRVA250T	Ultralite 2	80–250*

**Sales: 01243 781 559**

Dimensions given refer to internal diameter of pot or flue. All prices exclude VAT. Minimum carriage paid order £150 Ex VAT. £10 Ex VAT carriage applies if under £150 Ex VAT NET order.

# Revolving & Electric Anti-Downdraught Cowls

## Rotorvent Turbolite®

This relatively new revolving cowl is lighter, more aerodynamic and more efficient than the original Rotorvent® and now comes with an additional strap fixing kit included.

The same high specifications that made the original Rotorvent® such a popular product are included in this product as standard. Fins are made from stainless steel, and the same fin fixing method which has been tried and tested for many years is still utilised.

Order code	Reference	Size mm
CCRVL250	Turbolite	80 - 250

- Lightweight
- Better performance
- Improved aerodynamics
- Tested to BSEN 16475-7:2016 & BSEN-1856-1:2003
- Comes complete with strap fixing kit option as well as hook bolts
- Money back guarantee
- For areas of consistently high wind speeds a static chimney cowl such as the Colt Top (page 7) may be more appropriate
- Stainless steel
- Suitable for smokeless fuels

**The burning of wet or unseasoned wood and installation below 4m from the fire must be avoided when using revolving cowls**



## Mini Rotorvent®



Order code	Reference	Size mm
CCRV1800	Mini Rotorvent®	80-180

**The Mini Rotorvent® is designed to fit smaller flues and is also suitable for use on landfill sites and methane vent pipes.**

- Fits flues 80-180mm flue sizes
- Stainless steel rotor structure
- Pressure die cast aluminium base
- Money back guarantee
- Suitable for use on all fuels
- Suitable for use on twin wall flue pipe
- Tested to BSEN 16475-7:2016 & BSEN-1856-1:2003

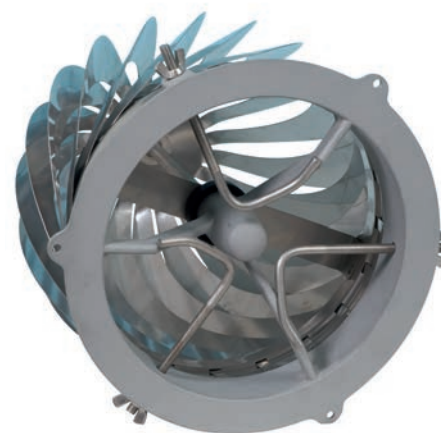

Base of the Turbolite showing greater surface area through which gasses may pass

Mini Rotorvent® and Turbolite



# Revolving & Electric Anti-Downdraught Cowls

# 13

## Electric Chimney Fans -The Draftbooster



As the name suggests, the Draftbooster eliminates the difficulties people sometimes face in attempting to light a stove that suffers from a lack of draw. The Draftbooster provides the necessary draught, making the stove lighting process a cinch whilst reducing the amount of smoke and odour in the room.



The worlds first 'plug and play' chimney fan also comes complete with remote control

The Draftbooster has great benefits:

- Adjustable fixings. The Draftbooster will fit both brick and steel chimneys with an internal maximum diameter of Ø220mm
- Less smoke spillage. The Draftbooster draws smoke up and away, minimising soot and smoke in the room
- Better combustion and faster heating. The Draftbooster provides better and cleaner combustion meaning the room warms up quicker
- Plug and play. The Draftbooster is easily installed and is the first 'plug and play' chimney fan worldwide.
- Works up to 250°C just below the chimney fan
- Can be used with woodburning stoves/ fireplace inserts with a rated output of 3 to max 8 (KW)
- All sheet parts are made of stainless steel EN1.4301/AISI304
- Developed according to requirements in PrEN16475-2 (Chimney Fans)

Order code	Reference
DB7B02001	Draftbooster (black)
DB7S02001	Draftbooster (silver)

## Square Adapter Kit



Square Adapter Plate Components

Order code	Reference	Size mm
CCSQAD01	Square Adapter	330 x 330

- Can be used on difficult installations
- 4 Fixing slots to top of chimney
- Stainless steel fixings to mount Rotorvents® including Allen (hexagon) key
- Dimensions 330mm x 330mm
- Fixings can be secured from 273mm x 273mm up to 310mm x 310mm
- 6mm thick durable aluminium alloy

## Rotorvent® Reduction Plate



Order code	Reference	Size mm
CTAD0100	Adapter*	100
CTAD0125	Adapter*	125
CTAD0150	Adapter*	150
CTAD0175	Adapter	175
CTAD0200	Adapter	200

An accessory for use with Rotorvent® when the flue dimension is between 125-175mm.

- 1.0mm aluminium
- Sits between the chimney pot and the Rotorvent®
- For use on the Ultralite 2 and the Rotorvent® Turbolite but not the Mini-Rotorvent®

\*See Mini Rotorvent® page 12

## Rotorvent® Opening Kit



Order code	Reference	Size mm
CCOU0001	Opening Kit	80-250

Optional opening kit which fits underneath the Rotorvent® base and allows the product to be opened whilst still fixed to the chimney.

- Simple to fit
- Ensures there is no damage to the Rotorvent® during chimney cleaning
- Suitable for both Turbolite and Ultralite 2.

# Sales: 01243 781 559

Dimensions given refer to internal diameter of pot or flue.  
All prices exclude VAT. Minimum carriage paid order £150 Ex VAT.  
£10 Ex VAT carriage applies if under £150 Ex VAT NET order.





## High Top Flex

This great new product from Colt Cowls revolutionises the method of installing a cowl or birdguard onto a flexible flue negating the removal of the chimney pot when installing.

- Popular High Top model
- Manufactured entirely from high quality stainless steel
- Connects straight to chimney liner and chimney pot
- Robust base allows product to be easily centred on pot and provides great strength
- Saves time and money
- Strap fixing kits included for connecting to both chimney liner and chimney pot



### Fuel Type Chart

	Coal	Wood	Gas	Oil	Smokeless Fuels
High Top Flex Cowls	✓	✓		✓	✓

Order code	Reference	Size mm
SHTFT125	High Top Flex Terracotta 125	125mm liner/ 125-250mm pot
SHTFT150	High Top Flex Terracotta 150	150mm liner/ 125-250mm pot
SHTFS125	High Top Flex Natural 125	125mm liner/ 125-250mm pot
SHTFS150	High Top Flex Natural 150	150mm liner/ 125-250mm pot

## High Top Flex Terracotta 316 Stainless Steel

The High Top Flex is now available in high grade 316 stainless steel.

- Made entirely from 316 stainless steel
- Kitemarked product
- Suitable for all solid fuels including, logs, coal, and all smokeless fuels (Anthracite, Phurnacite, coke).
- Robust base allows product to be easily centred on pot and provides great strength
- Saves time and money
- Strap fixing kits included for connecting to both chimney liner and chimney pot
- Meets regulation BSEN 16475-7:2016
- Lifetime guarantee



KM 645037  
BS EN 16475-7:2016



**Lifetime Guarantee**

Order code	Reference	Size mm
HF316125	High Top Flex Terracotta 125 SS316	125mm liner/ 125-250mm pot
HF316150	High Top Flex Terracotta 150 SS316	150mm liner/ 125-250mm pot



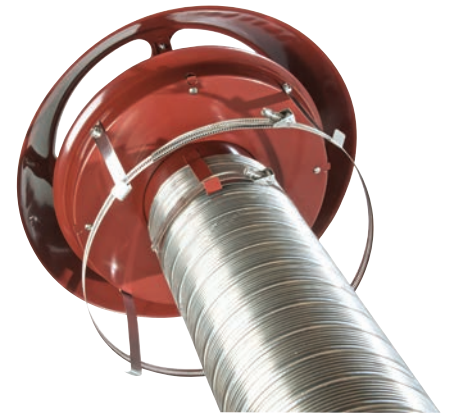

## Colt Top Flex

**The most popular anti-downdraught cowl on the market, the Colt Top is now available as a stainless steel chimney liner cowl. The Colt Top can now be installed onto flexible flue liner without the need to remove the chimney pot.**

- Manufactured entirely from high quality stainless steel
- Connects straight onto chimney liner and chimney pot
- Anti-downdraught
- Popular Colt Top model. Approximately one million sold since 1985
- Strap fixing kits included for connecting to both chimney liner and chimney pot
- Saves time and money for installers and home owners
- Excellent at preventing rain entry

Order code	Reference	Size mm
CTFT125	Colt Top Flex Stainless Steel (Terracotta)	125mm
CTFT150	Colt Top Flex Stainless Steel (Terracotta)	150mm

### Fuel Type Chart

	Coal	Wood	Gas	Oil	Smokeless Fuels
Colt Top					
Flex Cowls	✓	✓	✓*	✓	✓

\*Must order birdguard separately - code CTBK0001.

## Star Flex Adapter - Flexible Flue Liner

**The Star Flex adapter allows chimney liner to be supported from the top of the chimney pot while the installer backfills with a loose insulation material such as vermiculite around the outside of the liner.**

It can also be used on its own, or in conjunction with either a standard Colt chimney cowl or a suspending cowl such as the Colt Top Flex or High Top Flex. When installing with a suspending cowl, simply nip off the stainless steel legs on the spigot.

- Constructed entirely from stainless steel
- Easy to fix to liner using robust worm screw arrangement
- Supports liner from the top of the chimney pot
- Allows enough space to pour back fill down the outside of the flue liner
- Fits all flue liners regardless of brand
- Can be used in conjunction with any standard Colt chimney cowl, or suspending cowl such as Colt Top Flex and High Top Flex
- Available for 125 and 150mm liner
- Suitable for chimney pots up to 250mm internal diameter



Order code	Reference	Size mm
CCSTA125	Star Adapter 125	125
CCSTA150	Star Adapter 150	150

# Sales: 01243 781 559

Dimensions given refer to internal diameter of pot or flue.  
All prices exclude VAT. Minimum carriage paid order £150 Ex VAT.  
£10 Ex VAT carriage applies if under £150 Ex VAT NET order.



## Flexiwall™ Chimney Liner

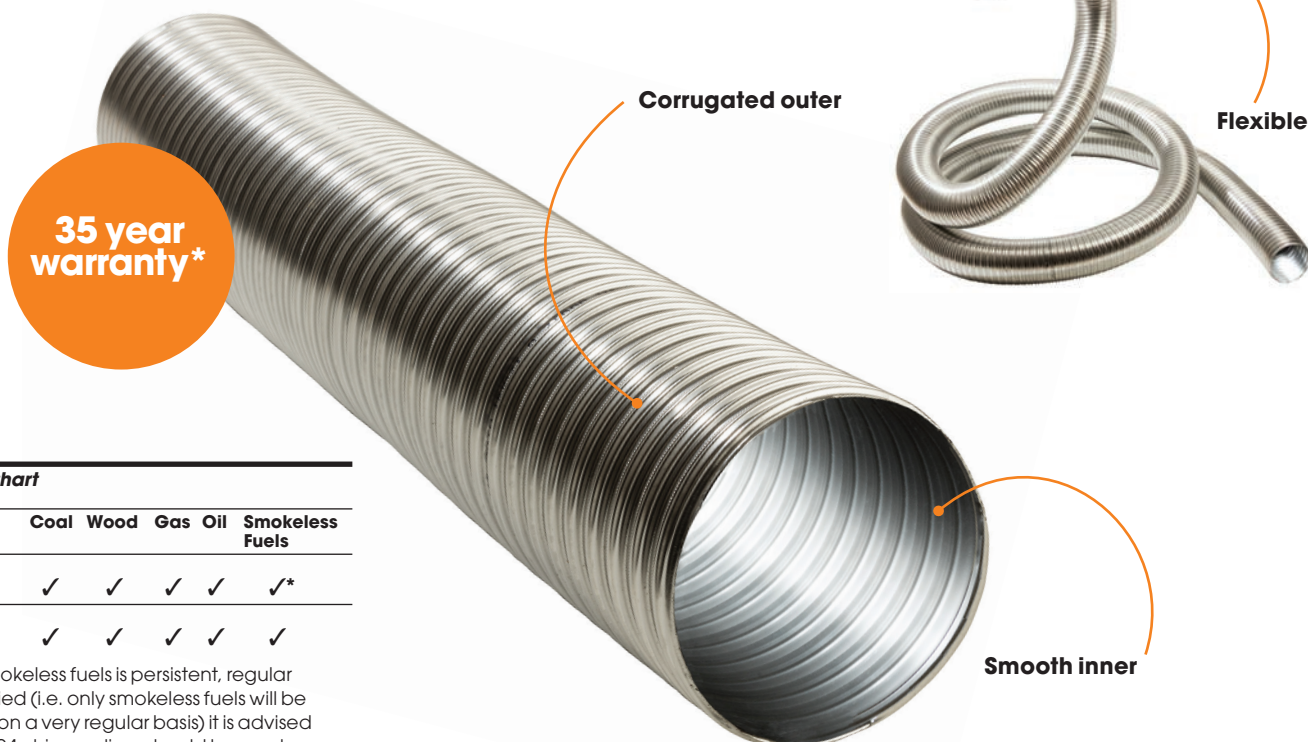

### Fuel Type Chart

	Coal	Wood	Gas	Oil	Smokeless Fuels
CC Flexiwall 316/316	✓	✓	✓	✓	✓*
CC Flexiwall 904/904	✓	✓	✓	✓	✓

\* If use of smokeless fuels is persistent, regular and unvaried (i.e. only smokeless fuels will be burnt and on a very regular basis) it is advised that 904/904 chimney liner should be used.

## Flexiwall™ Chimney Liner

**Flexiwall™ chimney liner is one of the best quality chimney liners on the market. The 904/904 version is offered with a 35 year warranty, and the 316/316 version 20 years highlighting the manufacturers commitment to quality and sales back up.**

The interior of the liner is widely believed to be the smoothest available on the market providing clear passage for smoke and flue gases from solid fuel and wood burning appliances. The even inside surface means that there is far less likelihood of soot deposit build up which can create acidic erosion of the stainless steel. Many inferior quality chimney liners suffer from this problem.

The chimney liner is manufactured in such a way that it is both flexible and strong.

Presented alongside Colt Cows wide selection of chimney liner components, customers can be certain they are purchasing products that are built to last.

- Compliant with BSEN1856-2:2009 and BSEN 1443:2003
- 316/316: T450P2DVML50024G
- 904/904: T450N2DVM70012G
- Next day delivery
- HETAS listed



## Flexiwall™ 316/316 Stainless Steel Solid Fuel Liner

Order Code	Reference	Ø mm	Length m
CCFS10005	CC Flexiwall™ 316 x 125	125	1.0
CCFS10006	CC Flexiwall™ 316 x 150	150	1.0
CCFS10007	CC Flexiwall™ 316 x 175	175	1.0
CCFS10008	CC Flexiwall™ 316 x 200	200	1.0

## Flexiwall™ 904/904 Stainless Steel Solid Fuel Liner

Order Code	Reference	Ø mm	Length m
CCFS10205	CC Flexiwall™ 904 x 125	125	1.0
CCFS10206	CC Flexiwall™ 904 x 150	150	1.0
CCFS10207	CC Flexiwall™ 904 x 175	175	1.0
CCFS10208	CC Flexiwall™ 904 x 200	200	1.0

## Chimney Liner - Gas & Oil

Order Code	Reference	Ø mm	Length m
GF10005	Gas & Oil Liner	125	1.0
GF10006	Gas & Oil Liner	150	1.0
GF10007	Gas & Oil Liner	175	1.0
GF10008	Gas & Oil Liner	200	1.0

**NB** Orders below 40m are subject to a delivery charge. Orders to postcodes AB IV KW PH BT and to all islands will incur additional delivery charges whether for 1m or 40m

When accessories are ordered in non-pack sizes in conjunction with the liner net prices apply.

\*35 year warranty applies to 904/904. 316/316 has a 20 year warranty. Warranty registration required. Delivery charges may apply.



## Turner & Wilson Twinflex Chimney Liner



See pages  
18-21 for our  
full range of  
accessories

Turner and Wilson is a brand synonymous with quality and specified by countless professional installers who regard Twinflex as a superb liner and quite simply the best on the market!

Colt Cows are proud to offer the Turner and Wilson brand because it shares many of the core values Colt Cows have worked hard to live by over the years. Established in 1964, Turner and Wilson flue liners have, like Colt Cows (est. 1931) stood the test of time, and there is no greater test than that. The product is manufactured with quality in mind rather than profit, and the robust yet flexible construction gives uncompromisingly, the best possible performance for both installation and use.

Available in a range of diameters and in both 316/316 and 904/904 stainless steel, Twinflex is offered with NEXT DAY delivery to mainland UK.

- Twinflex has been tested and passed by BSRIA to EN 1856-2 with the designation of T600. N. D3. Vml40010 G(25)
- Wonderful ability to absorb thermal shock
- Optimum flexibility for installation.
- Completely over-lapping inner skin for long life
- Exceptionally smooth bore
- High Spring factor for ease of fitting
- Huge crush and torque resistance
- HETAS listed



### Fuel Type Chart

	Coal	Wood	Gas	Oil	Smokeless Fuels
Twinflex 316/316	✓	✓	✓	✓	✓*
Twinflex 904/904	✓	✓	✓	✓	✓

\* If use of smokeless fuels is persistent, regular and unvaried (i.e. only smokeless fuels will be burnt and on a very regular basis) it is advised that 904/904 chimney liner should be used.

## Turner & Wilson Twinflex 316/316 Chimney Liner

Order Code	Reference	Ø mm	Length m
5TF	Twinflex 316 x125	125	1.0
6TF	Twinflex 316 x150	150	1.0
7TF	Twinflex 316 x175	175	1.0
8TF	Twinflex 316 x 200	200	1.0

## Turner & Wilson Twinflex 904/904 Chimney Liner

Order Code	Reference	Ø mm	Length m
5TF9X	Twinflex 904 x125	125	1.0
6TF9X	Twinflex 904 x150	150	1.0
7TF9X	Twinflex 904 x175	175	1.0
8TF9X	Twinflex 904 x 200	200	1.0

**NB** Orders below 40m are subject to a delivery charge. Orders to postcodes AB IV KW PH BT and to all islands will incur additional delivery charges whether for 1m or 40m

When accessories are ordered in non-pack sizes in conjunction with the liner net prices apply.

\*35 year warranty applies to 904/904. 316/316 has a 20 year warranty. Warranty registration required. Delivery charges may apply.

# Sales: 01243 781 559

Dimensions given refer to internal diameter of pot or flue. All prices exclude VAT. Minimum carriage paid order £150 Ex VAT. Delivery charges apply for chimney liner and all flue pipe.

## Adapter

- High quality stainless steel
- Connects stove pipe to flexible flue liner



Order Code	Reference	Ø mm
CCSFFFA125	Stove pipe to flex adaptor (MA)	125
CCSFFFA150	Stove pipe to flex adaptor (MA)	150

## Fixing plate & Clamping Bracket

- Used in conjunction with one another
- Fixing plate used at the top of a chimney along with bracket to fix chimney liner in place

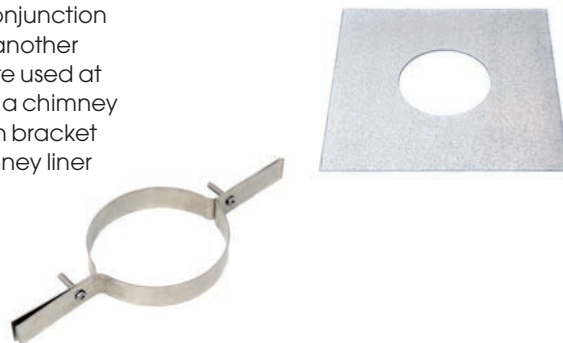

Order code	Reference	Ø mm
CCSFFFP125	Fixing plate (400mm x 400mm)	125
CCSFFFP150	Fixing plate (400mm x 400mm)	150
CCSFFCB125	Clamp	125
CCSFFCB150	Clamp	150

## Increasing adaptor

- High quality stainless steel
- Connects smaller diameter stove pipe to larger diameter flexible flue liner



Order Code	Reference	Ø mm
CCSFFIA125	Increasing adaptor (MR)	125 - 150

## Insert Sleeve

- High quality stainless steel
- Strengthens the top of a chimney liner when attaching the clamping bracket



Order code	Reference	Ø mm
CCSFFIS125	Insert Sleeve	125
CCSFFIS150	Insert Sleeve	150

## Nose Cone

- High quality stainless steel
- Fitted to the end of a chimney liner to protect and guide the liner down the chimney when installing



Order code	Reference	Ø mm
CCSFFNC125	Nose cone	125
CCSFFNC150	Nose cone	150

## Sump adapter

- Connects stove pipe to the underside of a clay chimney liner
- Top 'plate' part of the adapter measures 310mm



Order code	Reference	Ø mm
SFSA05	Sump adapter	125
SFSA06	Sump adapter	150

## Register Plates

- Seals off chimney opening to prevent dust and debris falling back down into the room



Order code	Reference	Ø mm
RP105	Register Plate 300 x 900mm	125
RP106	Register Plate 300 x 900mm	150
RP205	Register Plate 450 x 900mm	125
RP206	Register Plate 450 x 900mm	150
RP305	Register Plate 600 x 900mm	125
RP306	Register Plate 600 x 900mm	150

## Gather Unit

- Used at the base of a chimney when an open fire is installed



Order code	Reference	Ø mm
GH05	Gather unit 300 x 300mm	125
GH06	Gather unit 300 x 300mm	150

## Screwflex adapter

- High quality stainless steel
- Screws onto **flexiwall** chimney liner



Order Code	Reference	Ø mm
SFA05	Screwflex Adapter	125
SFA06	Screwflex Adapter	150

## Screwflex increasing adapter

- High quality stainless steel
- Screws onto **flexiwall** chimney liner. Connects smaller diameter flue to larger diameter **flexiwall**



Order Code	Reference	Ø mm
SFIA05	Screwflex increasing adapter	100-125
SFIA06	Screwflex increasing adapter	125-150

## Connect adapter

- Connects two pieces of chimney liner together



Order Code	Reference	Ø mm
CA1505	Connect adapter	125
CA1506	Connect adapter	150

\*Other components and sizes available upon request

## Long Nose adapter

- Longer nose preferred by some installers



Order Code	Reference	Ø mm
FAL1305	Long nose adapter	125
FAL1306	Long nose adapter	150

## Top Hat adapter

- Allows flexible installation. Attaches to register plate meaning liner can be fitted and stove can be installed at a later date!



Order Code	Reference	Ø mm
THA05	Top Hat Adapter	125
THA06	Top Hat Adapter	150

## Top Hat increasing adapter

- Allows flexible installation. Attaches to register plate meaning liner can be fitted and stove can be installed at a later date!
- Connects smaller diameter flue to larger diameter flexible flue pipe



Order Code	Reference	Ø mm
THIA05	Top Hat Increaser	100-125
THIA06	Top Hat Increaser	125-150

## Register Plate adapter

- Allows flexible installation. Includes register plate meaning liner can be fitted and stove can be installed at a later date!



Order Code	Reference	Ø mm
RPA2205	Register Plate adapter	125
RPA2206	Register Plate adapter	150

## Register Plate increasing adapter

- Allows flexible installation. Includes register plate meaning liner can be fitted and stove can be installed at a later date!
- Connects smaller diameter flue to larger diameter flex



Order Code	Reference	Ø mm
RPIA05	Register Plate increasing adapter	125
RPIA06	Register Plate increasing adapter	150



## Flexwrap (1,2,3 & 4m lengths)



Flexwrap provides a versatile solution for insulating flexible flue liner when more conventional methods may be impractical.

- Easy to install
- Wraps can be combined together to suit any length of flue
- Includes Velcro fasteners
- Prolongs the life of the flue liner
- Fits 125 & 150mm flue liner

Order code	Reference	Size mm
FW101	Flexwrap	125 & 150mm (1m length)
FW102	Flexwrap	125 & 150mm (2m length)
FW103	Flexwrap	125 & 150mm (3m length)
FW104	Flexwrap	125 & 150mm (4m length)

## Vermiculite back fill insulation



Vermiculite back fill has traditionally been used to insulate chimney liner helping to prevent the build up of condensation in the flue. Insulating chimney liner in this way not only helps the chimney work efficiently but also helps to extend the life of the chimney liner.

- High quality back fill insulation
- 100 ltr bag

Order code	Reference	Size mm
V100	Vermiculite (Back fill insulation)	100ltr bag

## High Top Flex Stainless Steel (brown)



Order code	Reference	Size mm
SHTFT125	High Top Flex 125	125mm liner/ 125-250mm pot
SHTFT150	High Top Flex 150	150mm liner/ 125-250mm pot

## High Top Flex Stainless Steel (natural)



Order code	Reference	Size mm
SHTFS125	High Top Flex Natural 125	125mm liner/ 125-250mm pot
SHTFS150	High Top Flex Natural 150	150mm liner/ 125-250mm pot

## Colt Top Flex



Order code	Reference	Size mm
CTFT125	Colt Top Flex Stainless Steel (Terracotta)	125mm
CTFT150	Colt Top Flex Stainless Steel (Terracotta)	150mm

## High Top Birdguard Stainless Steel 316



Order code	Reference	Size mm
CTHTS316	High Top Stainless Steel 316	170-250

## Vitreous Enamel Flue Pipe



High quality vitreous enamel flue pipe for use with stoves and fireplaces. Connects to both flexible flue liner and twin wall flues.

## Vitreous Enamel Flue Pipe Ø125

Product Code	Description	Ø mm
CEPIPE250X5	CE Pipe 250mm x 125mm	125
CEPIPE250X5DAMPER	CE Damper Pipe 250mm x 125mm	125
CEPIPE500X5	CE Pipe 500mm x 125mm	125
CEPIPE1000X5	CE Pipe 1000mm x 125mm	125
CEPIPE500X5WD	CE Pipe 500mm x 125mm c/w Door	125
CEPIPE1000X5WD	CE Pipe 1000mm x 125mm c/w Door	125
CEBENDND45X5	CE Bend 45° x 125mm (No Door)	125
CEBENDWD45X5	CE Bend 45° x 125mm c/w Door	125
CEBENDND90X5	CE Bend 90° x 125mm (No Door)	125
CEBENDWD90X5	CE Bend 90° x 125mm c/w Door	125
CONTROLCETEE5M	Control CE Tee 125mm x 90° (No cap)	125
CEPIPECONMMX5	CE M To M Connector 120mm x 125mm	125
CONTROLCECAP5	Control CE Cap & Clamp 125mm	125
CEPIPE330X5TELE	CE Pipe 330mm x 125mm TELESCOPIC	125
CEBRACKET5	CE Wall Bracket 125mm	125

## Vitreous Enamel Flue Pipe Ø150

Product Code	Description	Ø mm
CEPIPE250X6	CE Pipe 250mm x 150mm	150
CEPIPE250X6DAMPER	CE Damper Pipe 250mm x 150mm	150
CEPIPE500X6	CE Pipe 500mm x 150mm	150
CEPIPE1000X6	CE Pipe 1000mm x 150mm	150
CEPIPE500X6WD	CE Pipe 500mm x 150mm c/w Door	150
CEPIPE1000X6WD	CE Pipe 1000mm x 150mm c/ w Door	150
CEBENDND45X6	CE Bend 45° x 150mm (No Door)	150
CEBENDWD45X6	CE Bend 45° x 150mm c/w Door	150
CEBENDND90X6	CE Bend 90° X 150mm (No Door)	150
CEBENDWD90X6	CE Bend 90° x 150mm c/w Door	150
CONTROLCETEE6M	Control CE Tee 150mm x 90° (No cap)	150
CONTROLCECAP6	Control CE Cap & Clamp 150mm	150
CEPIPE330X6TELE	CE Pipe 330mm x 150mm TELESCOPIC	150
CEBRACKET6	CE Wall Bracket 150mm	150



## Stove Installation Accessories

Product Code	Reference	Size
FR03	Fire Rope (Black) Per metre	3mm
FR06	Fire Rope (Black) Per metre	6mm
FR08	Fire Rope (Black) Per metre	8mm
FR12	Fire Rope (Black) Per metre	12mm
RA101	Fire Rope Adhesive	50ml
FS101	Fire Cement (Natural)	500g
FS100	Fire Cement (Natural)	1kg
FS102	Fire Cement (Natural)	2kg
FSB101	Fire Cement (Black)	500g
FSB100	Fire Cement (Black)	1kg
FSB102	Fire Cement (Black)	2kg
CNP	Chimney Data Plate	150mm x 85mm
HTS100	High Temp Silicone Sealant (Natural)	310ml
HTSB100	High Temp Silicone Sealant (Black)	310ml
THERM01	Stove Thermometer	60mm x 60mm
V100	Vermiculite Back Fill Insulation	100 litre
CMFA07	7 Year CO Alarm	112mm x 72mm

# Order stove glass from Colt Cows!

[www.coltcowls.co.uk](http://www.coltcowls.co.uk)

## Simple online ordering

- 1: Select brand
- 2: Select model
- 3: Select size
- 4: Select glass type

Use our easy drop-down, or call for an instant quote!



## Any size, any make, any model...



FRANCO BELGE

olsberg  
innovativ, seit 1577

THE PENMAN  
COLLECTION

STOVAX

THE  
GALLERY  
COLLECTION

Villager

charnwood

AGA

Arrow

ovie

tiger  
STOVES

JÖTUL

Glass by Schott Robax® • Low prices



Call the Sales Team  
now to place your order  
or for more information

Trade Terms Booklet  
available

Tel 01243 781 559  
Fax 0870 241 1042

www.coltcowls.co.uk  
Twitter @Coltcowls  
Facebook.com/coltcowls  
sales@coltcowls.co.uk

Colt Cowls Ltd  
Metro House, Northgate  
Chichester PO19 1BE



Available from:



Flexiwall and Turner & Wilson  
are HETAS listed



KM 645037  
BS EN 16475-7:2016